

Dabryan

Harness and

Connector

Schematics

Dabryan Harness and Connector

Table of contents

Page

1. Relay Board
2. Partition Main Harness
3. P/S Center Panel Harness
4. Rear of Limousine [Rear End of P/s Center Panel Harness]
5. D/S Center Panel Harness
6. Roof Harness
7. Heat and A/C Partition Harness
8. Underhood Harness
9. Factory Tie-In Harness
10. Front Faceplate Control Cable
11. RGB Lights Harness
12. 5th Door Car Harness
13. 5th Door Open Harness
14. 5th Door Relays Harness
15. Wire Color Codes

Connector Diagrams

16. C-1 and C-2
17. C-3 and C-4
18. C-5, C-6, C-7 and C-8
19. C-9, C-10 and C-11
20. C-12 and C-13
21. C-14 and C-15
22. C-16 and C-17
23. C-18, C-19 and C-20
24. C-21 and C-22
25. C-23, C-24 and C-25
26. C-26, C-27, C-28 and C-29
27. C-30, C-31 and C-32
28. C-33 and C-34
29. C-35
30. C-36, C-37 and C-38

POWER RELAY 2	PART UP	PART DOWN	POWER RELAY 3	VIDEO	VIDEO DISABLE	RADIO DISABLE	POWER RELAY 4
---------------	---------	-----------	---------------	-------	---------------	---------------	---------------

FLOOR
DOOR OVERRIDE
STAR
ACCENT
POWER RELAY 1
COACH
DUAL ALT
DUAL ALT

AC POWER 1
CON FAN
HEAT
AC BYPASS 1
AC BYPASS 2
AC POWER 2
BLOWER

VIDEO FUSE 10A	BLOWER 1 FUSE 25A	FRONT PANEL FUSE 15A
RADIO FUSE 15A	HEAT FUSE 15A	REAR PANEL FUSE 10A
SUBWOOFER FUSE 20A	BLOWER POT FUSE 1A	AUX 1 FUSE 15A
RADIO CON+ FUSE 15A	COACH CON+ FUSE 5A	BLOWER 2 FUSE 25A

CONSOLE FUSE 10A	STAR FUSE 10A	PARTITION FUSE 15A CB
CEILING FUSE 10A	ACCENT FUSE 15A	INTERCOM FUSE 3A
MOOD FUSE 10A	ICEBUCKET FUSE 5A	POWERPOINT FUSE 15A
FLOOR FUSE 10A	VANITY/NO SMOKE FUSE 5A	COND FAN FUSE 25A

WARNING

USE RECOMMENDED FUSE VALUES ONLY!

DABRYAN COACH IS NOT RESPONSIBLE FOR DAMAGE THAT OCCURS FROM OVER SIZED FUSES.

DaBryan Coach
1-800-842-5391

DIMMER

MAIN POWER

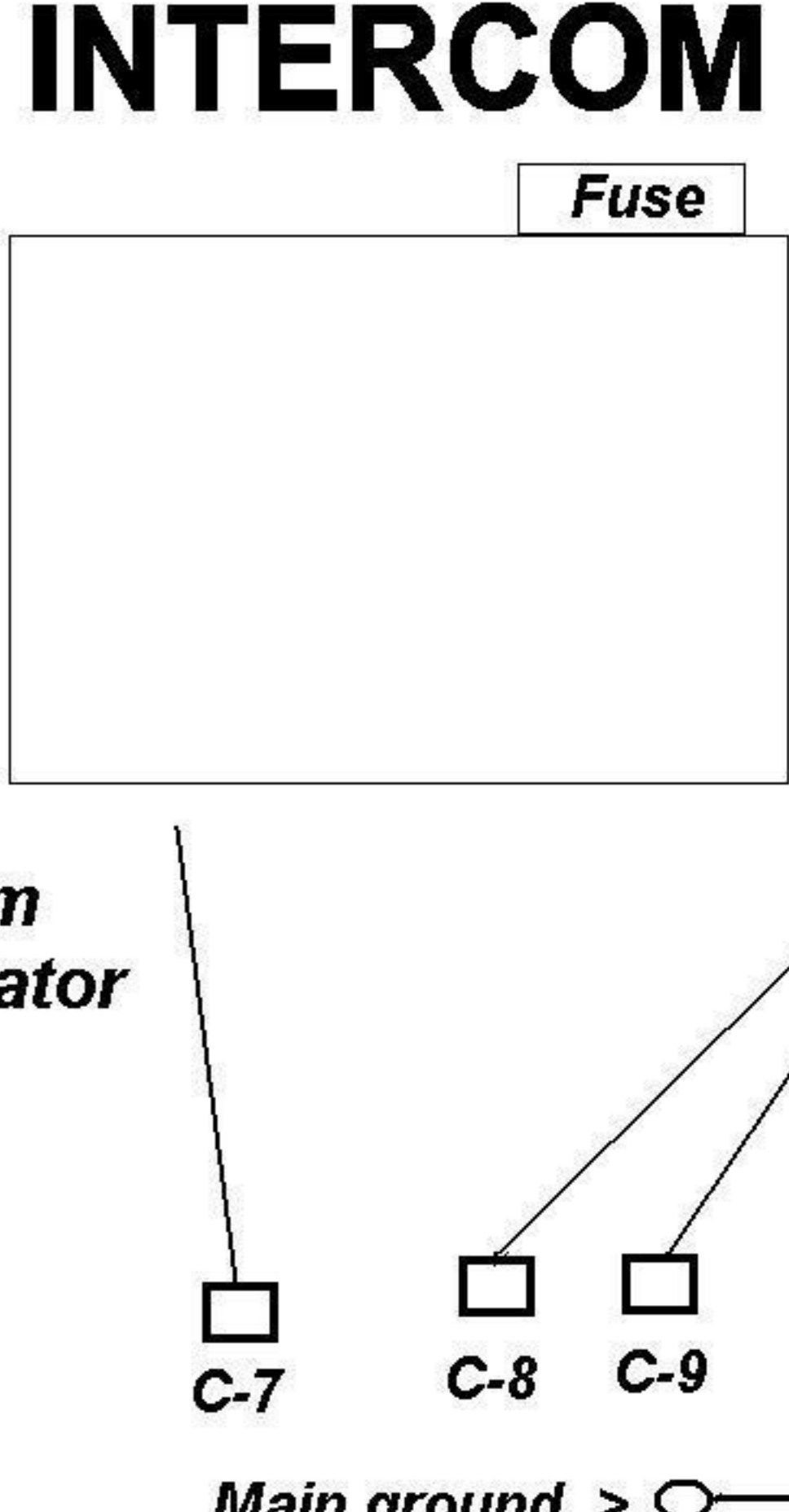
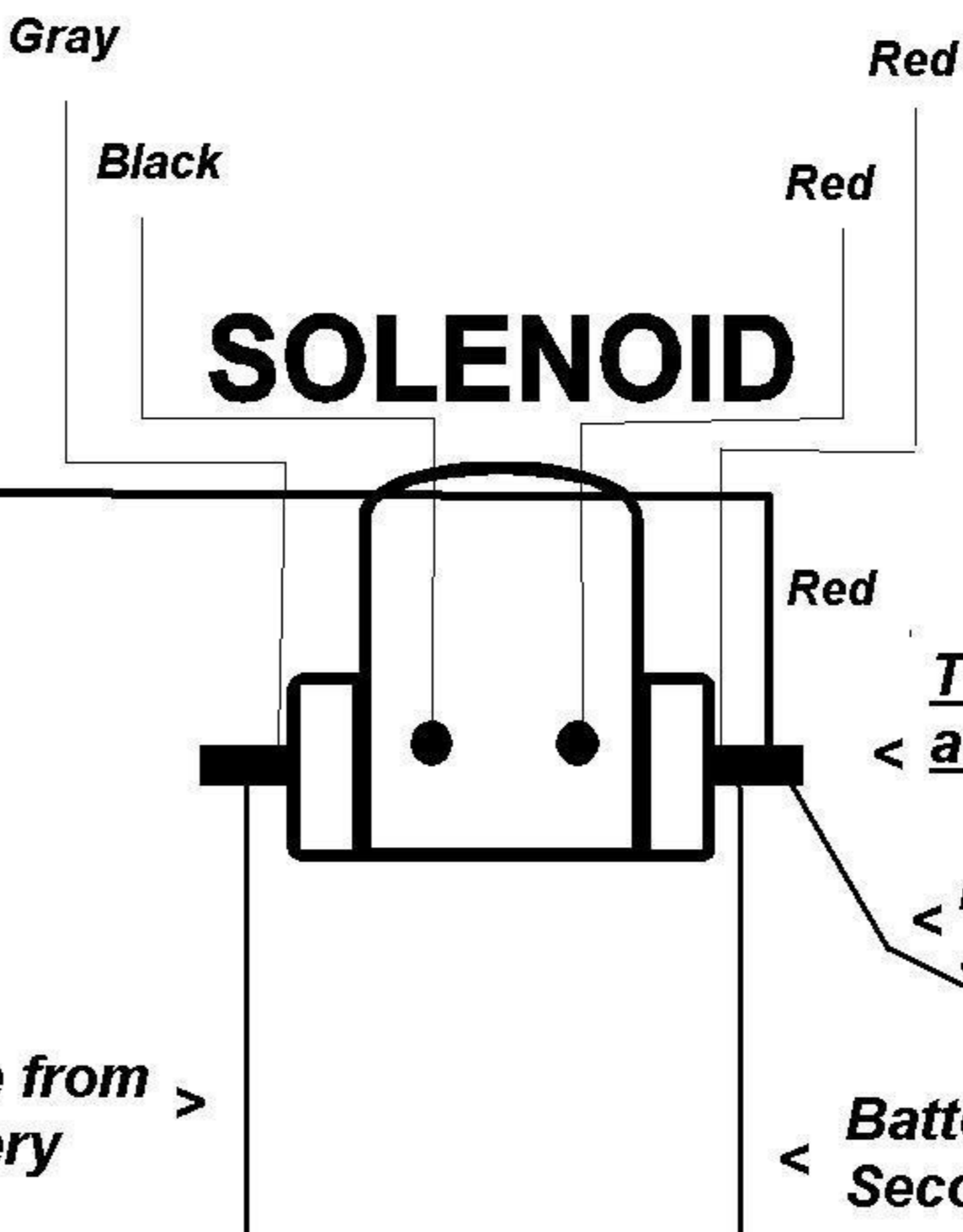
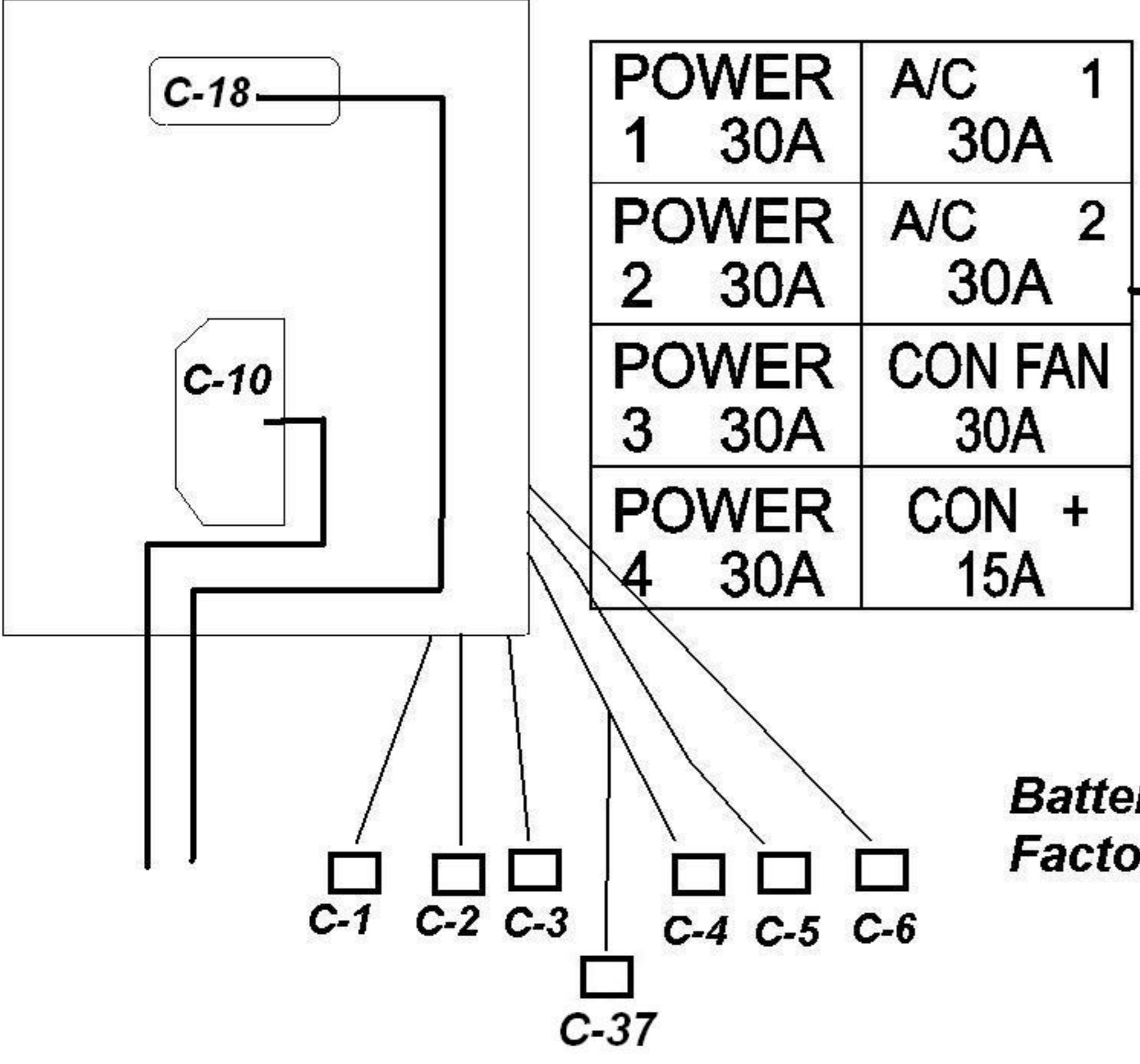

Partition Main Harness

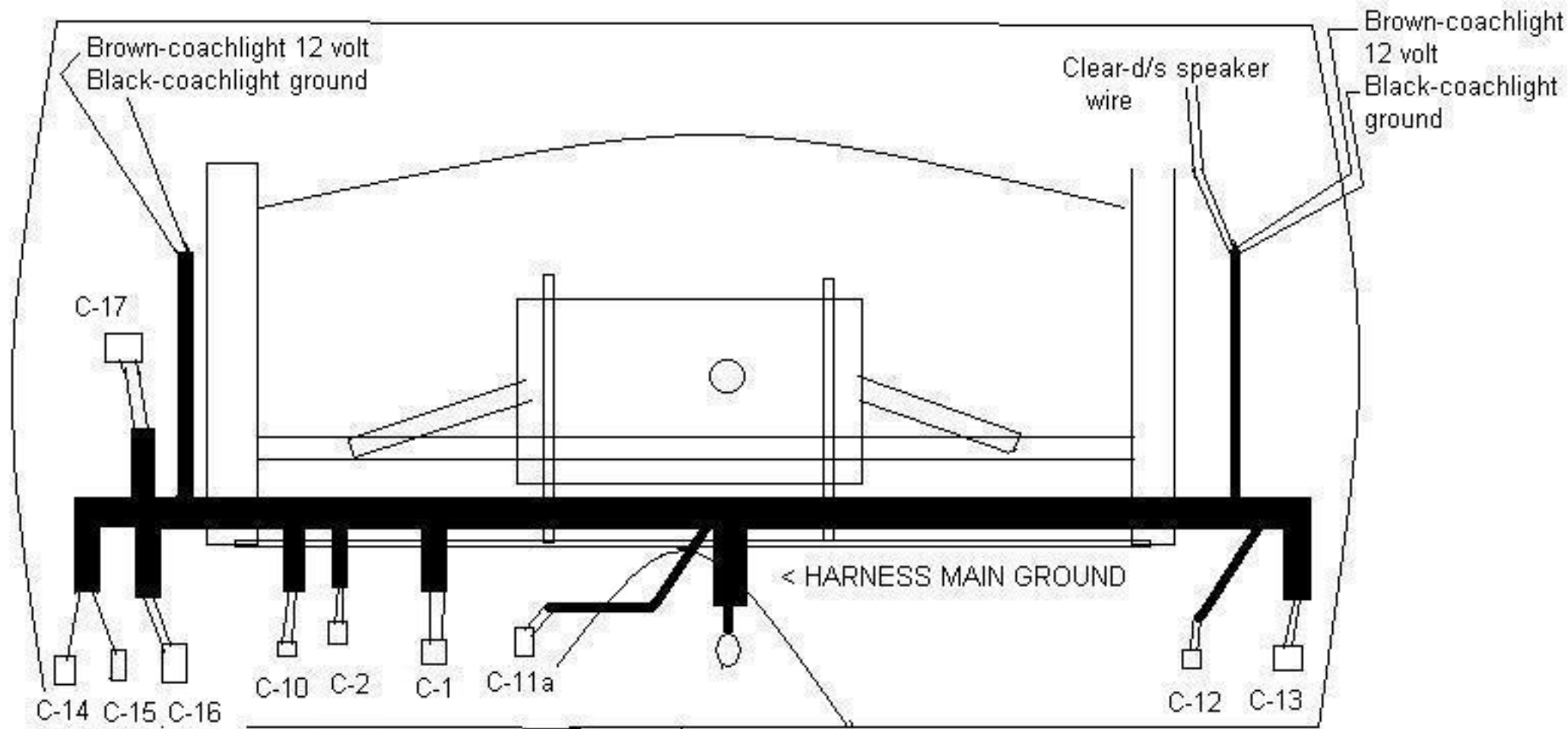

P/S CENTER PANEL

< FRONT

To Rear of
Limousine
[Top View]

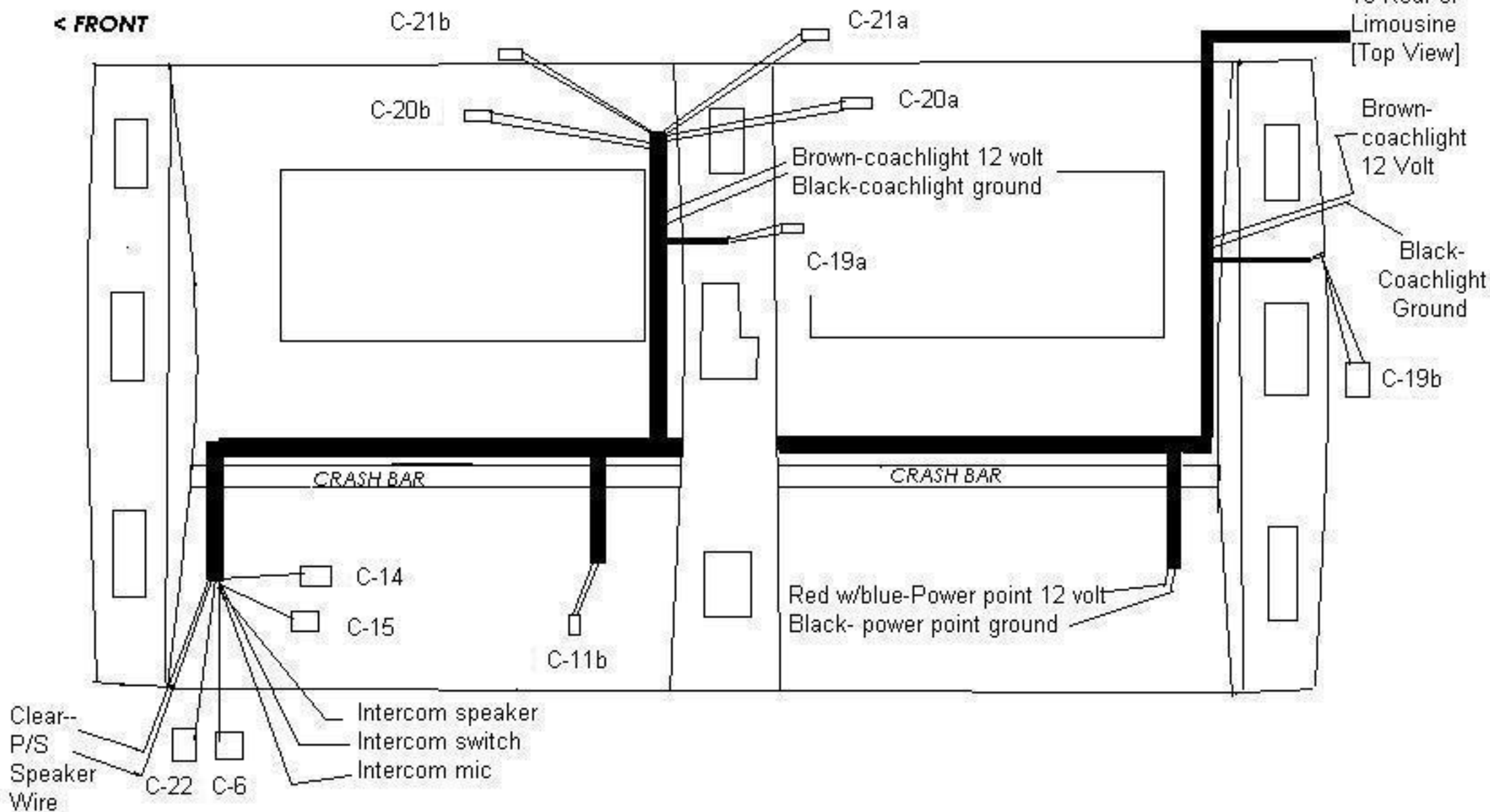

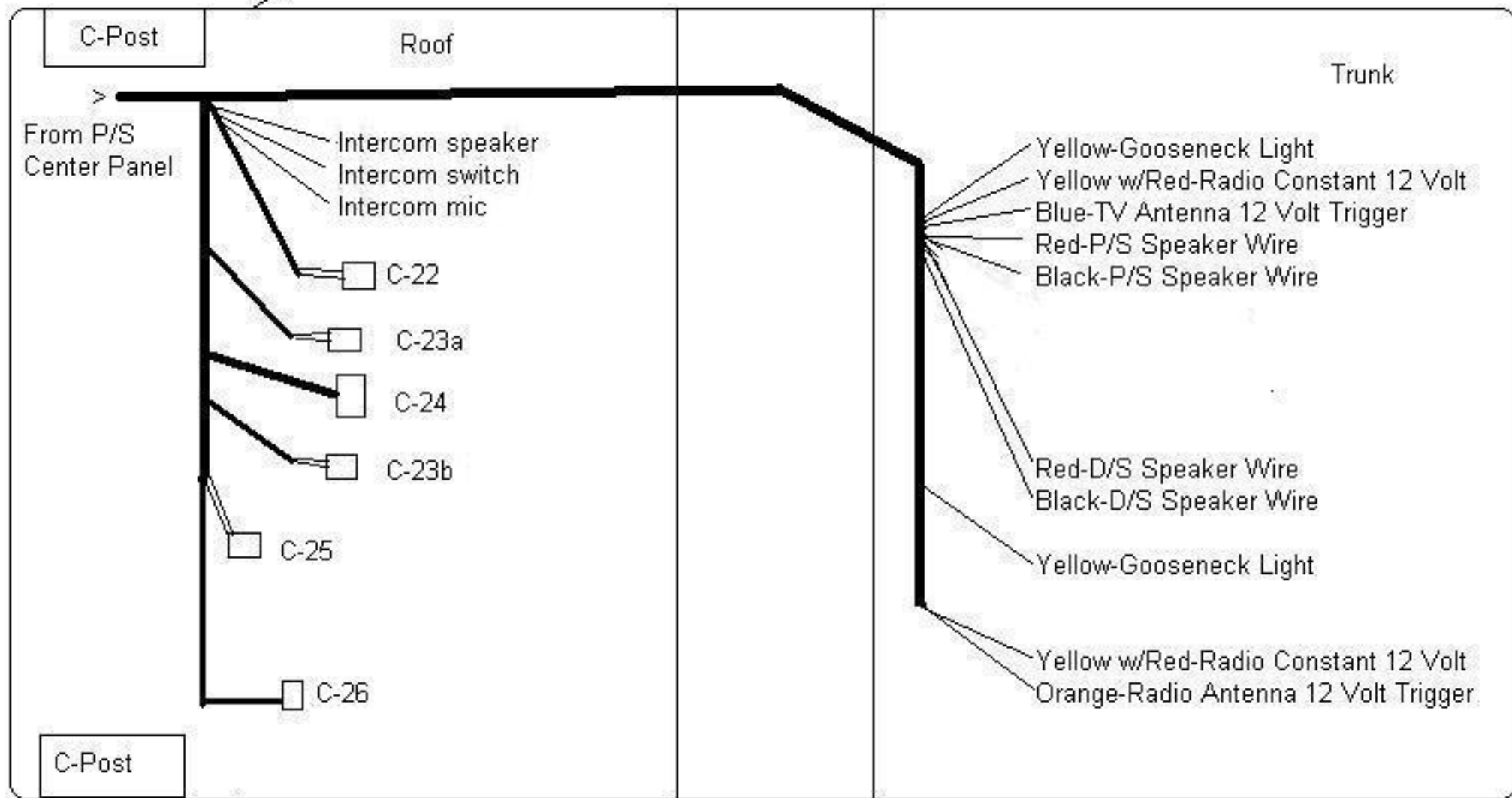

D/S CENTER PANEL

FRONT >

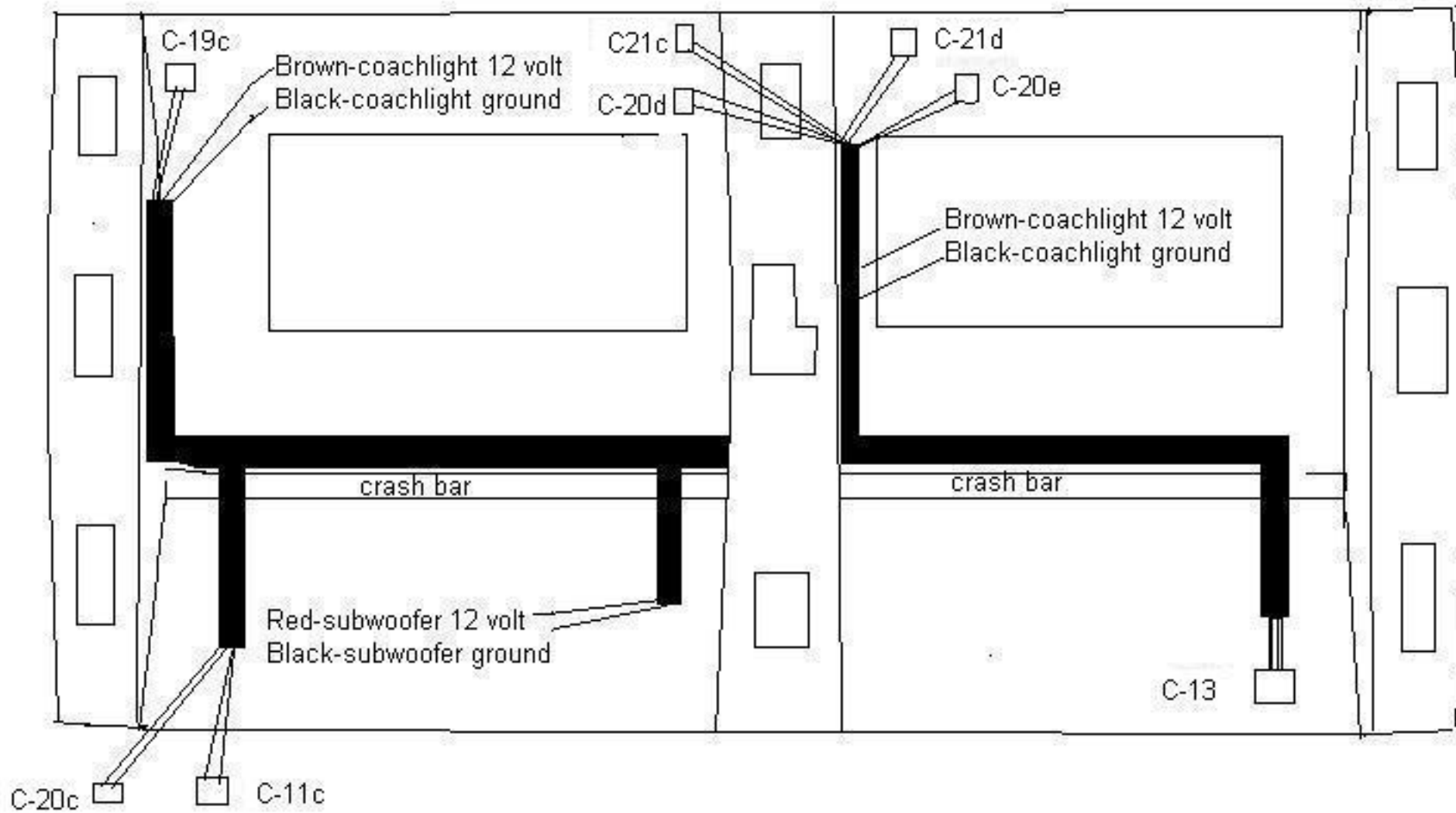

Top View Of Limousine

Roof Harness

<Front

Center Post

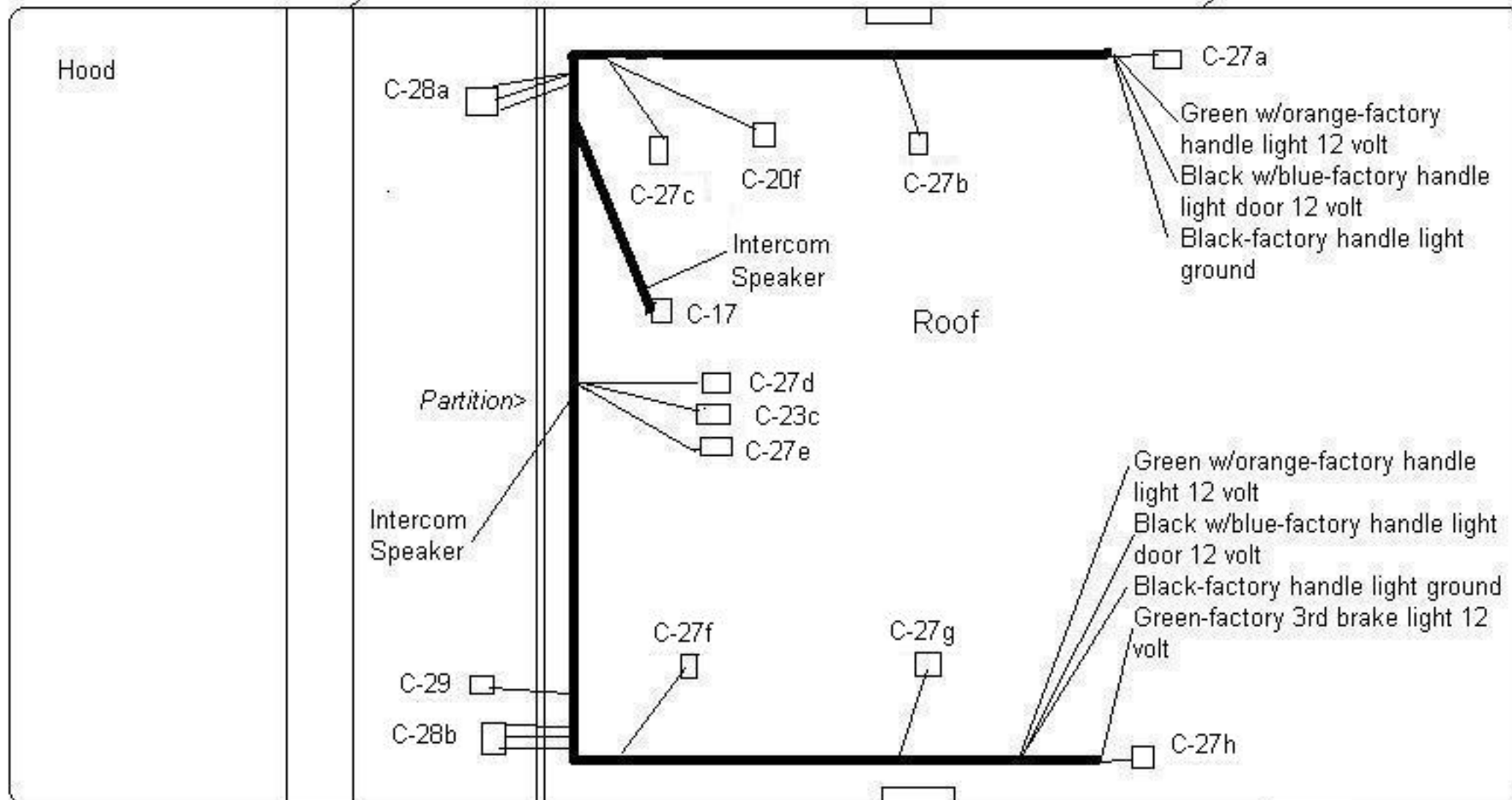

Heat and A/C Partition Harness

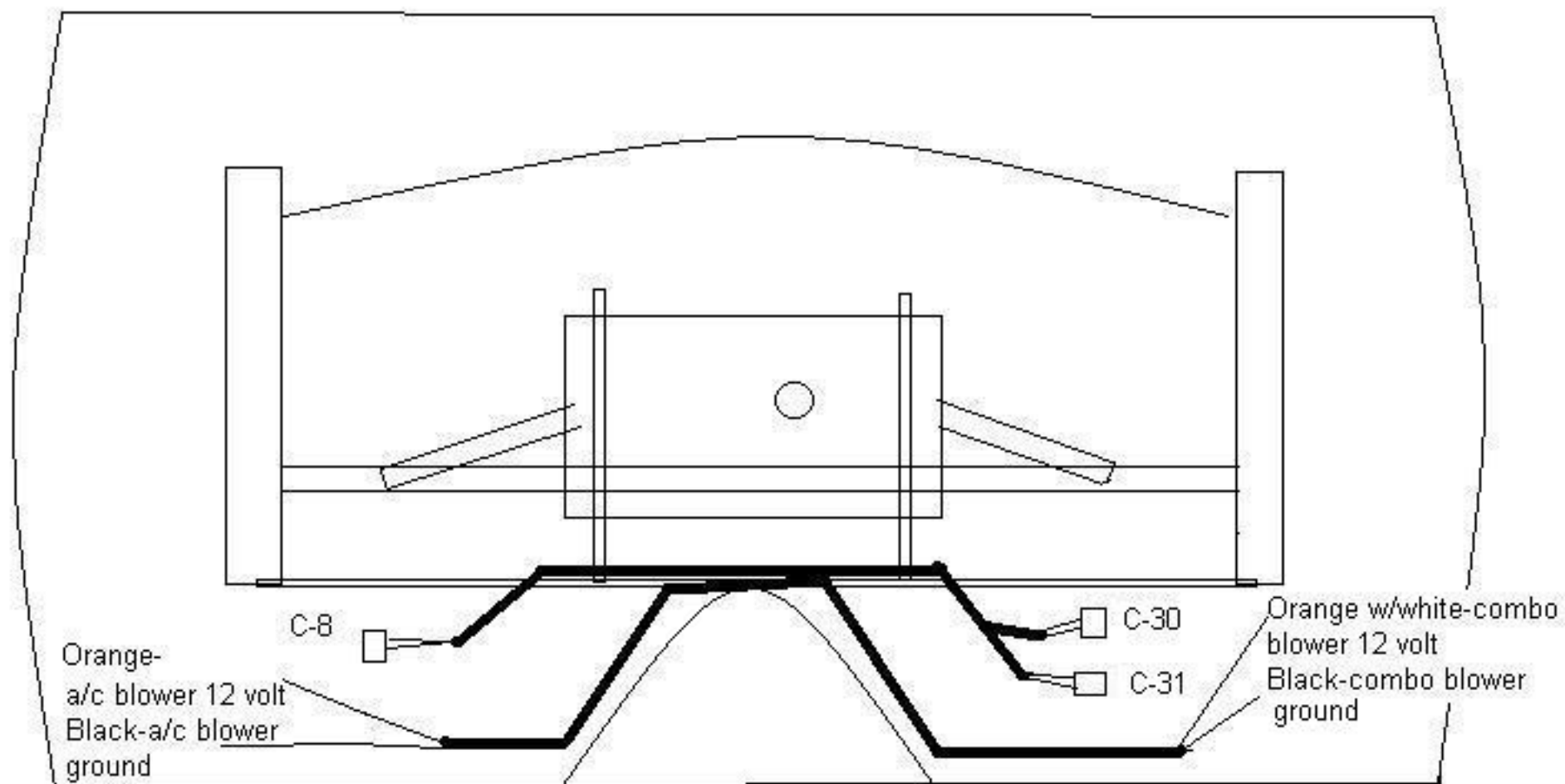

Underhood

<Front

Center Post

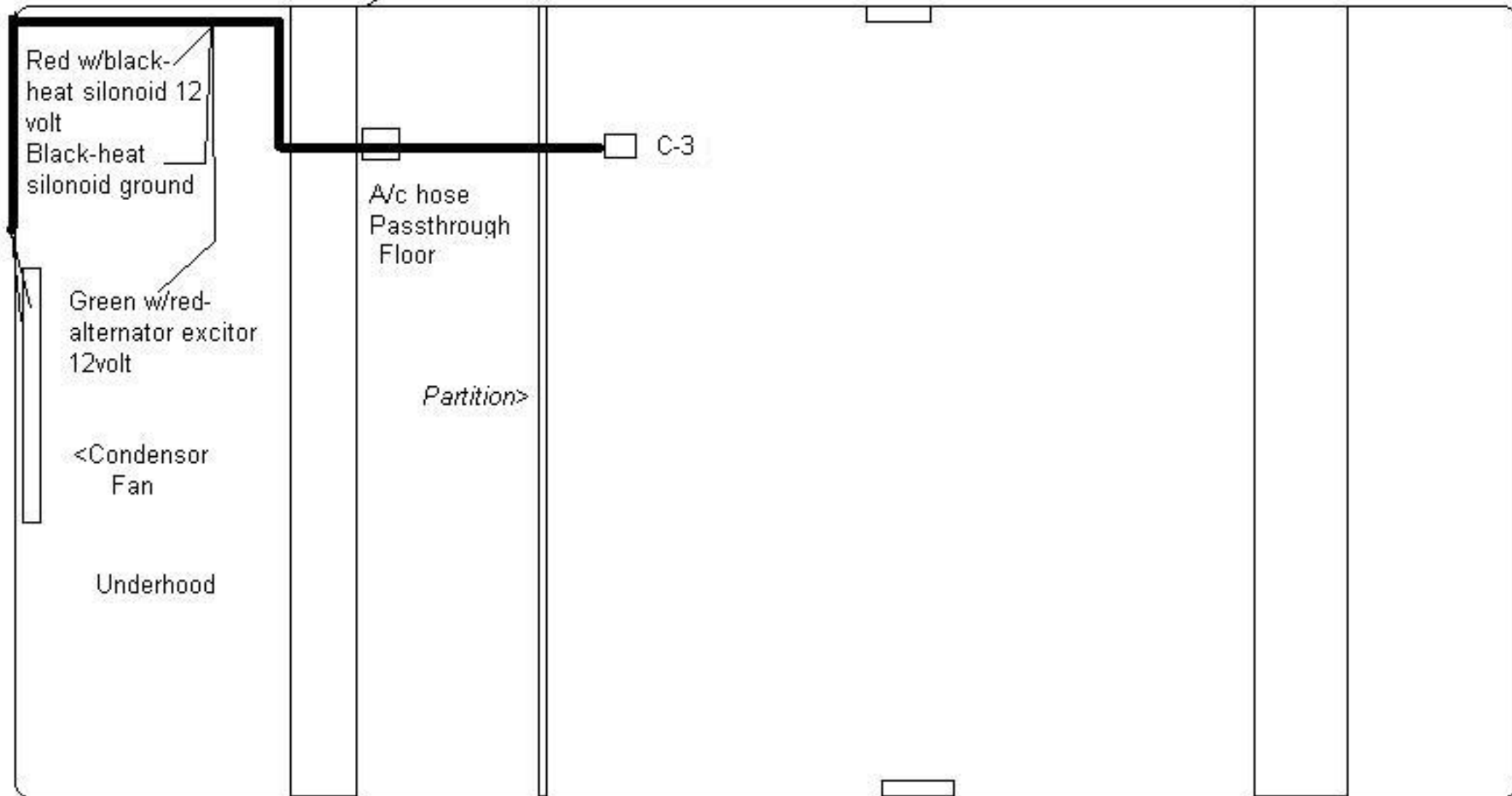

Factory Tie In Harness

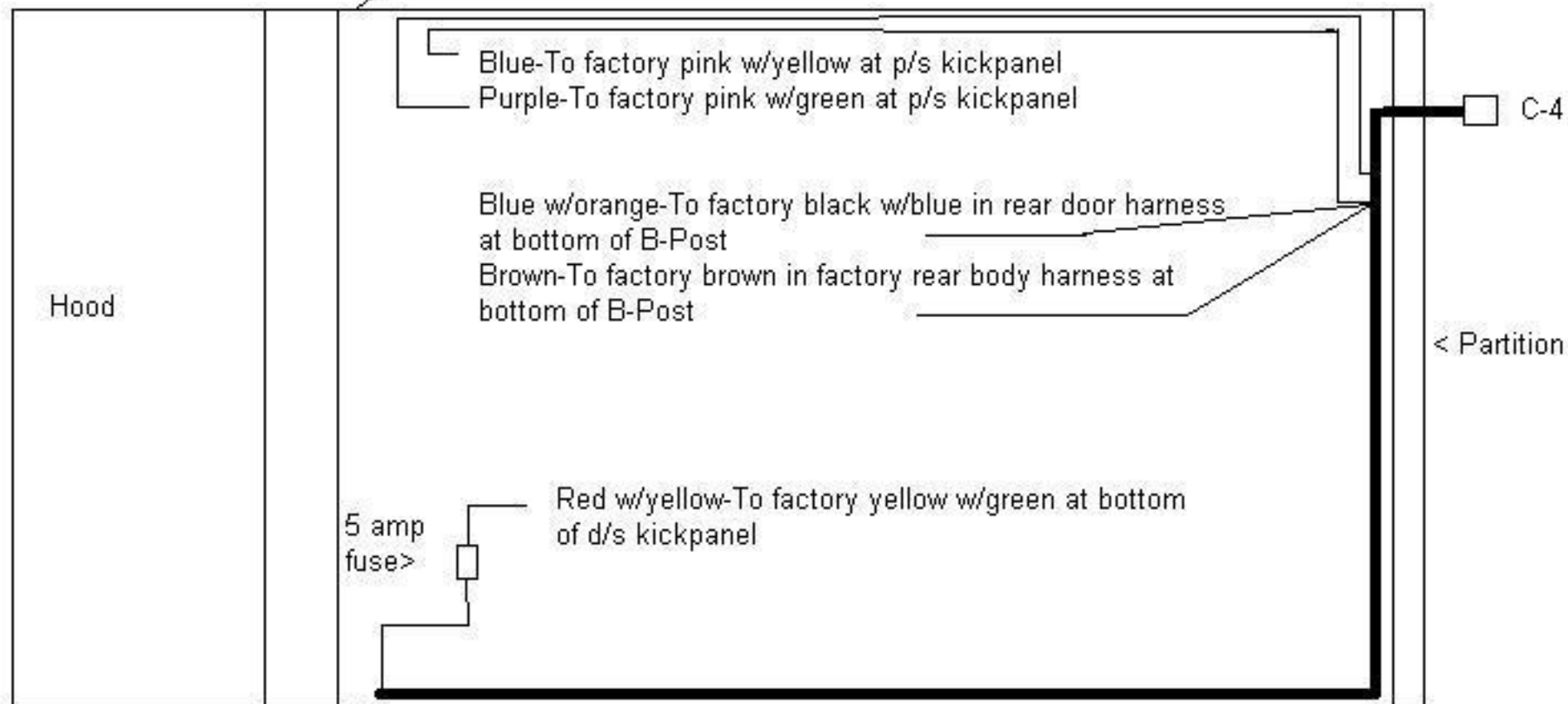

Front Faceplate Control Cable

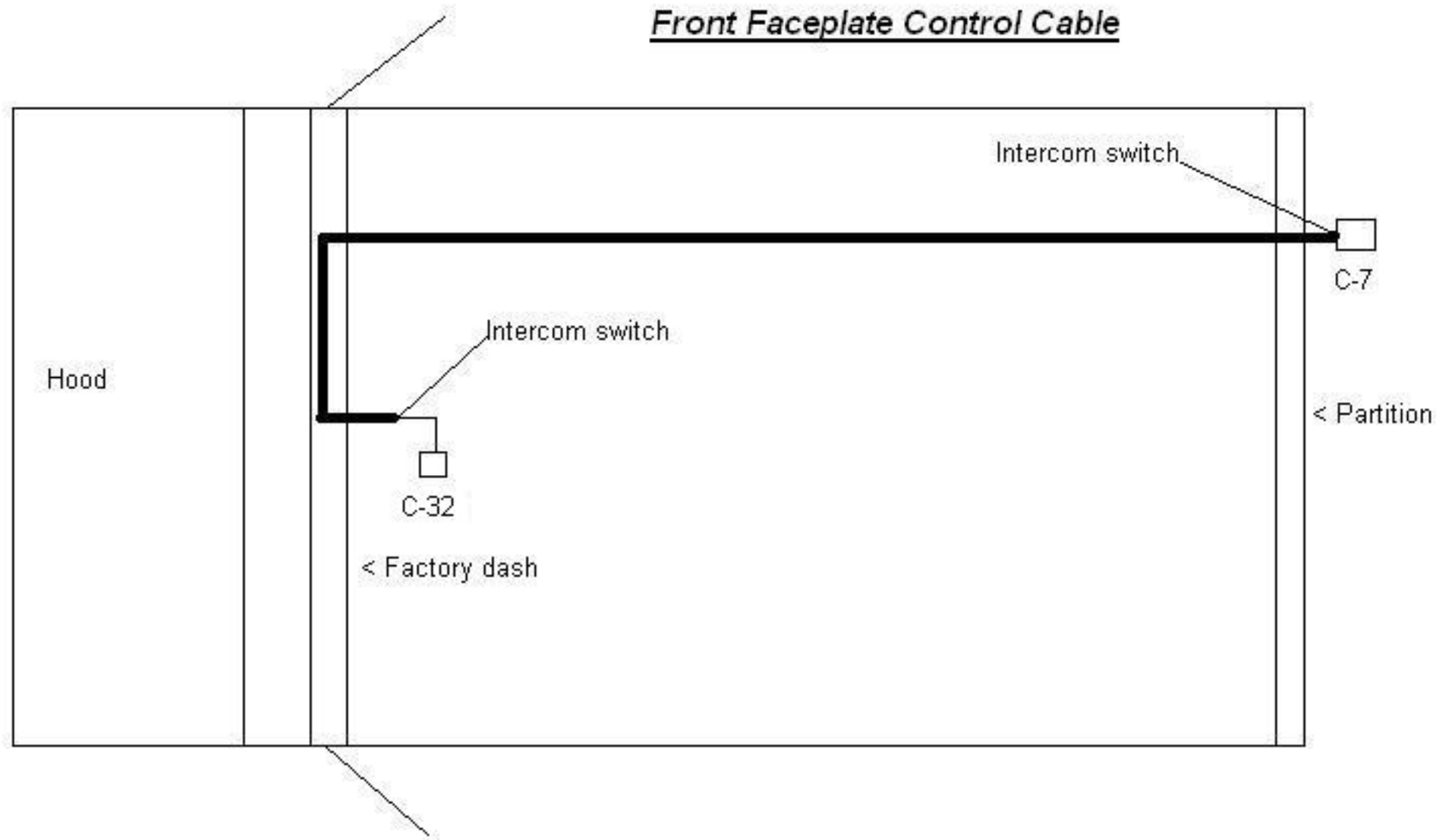

<Front

RGB Lights

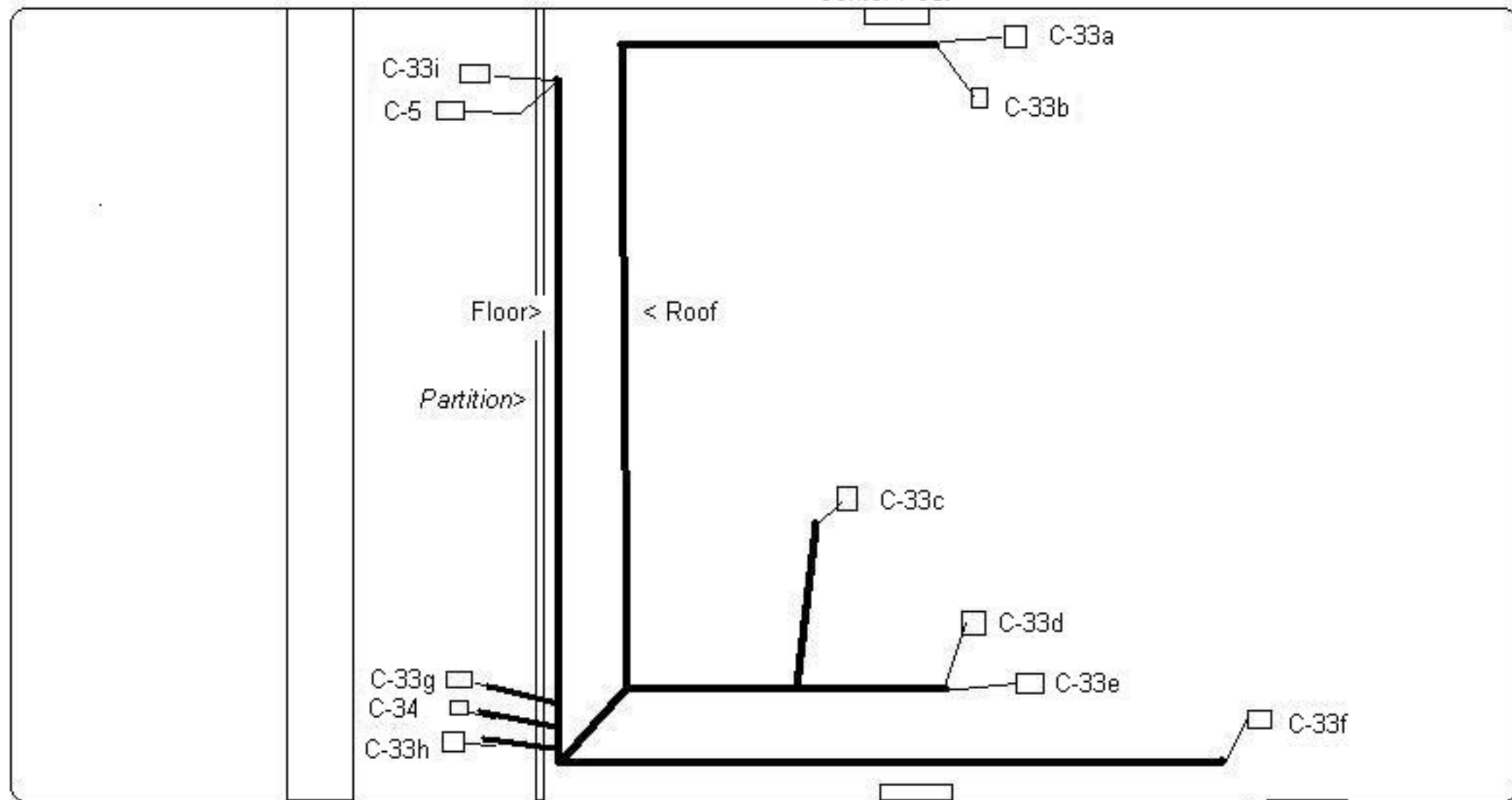

< Front

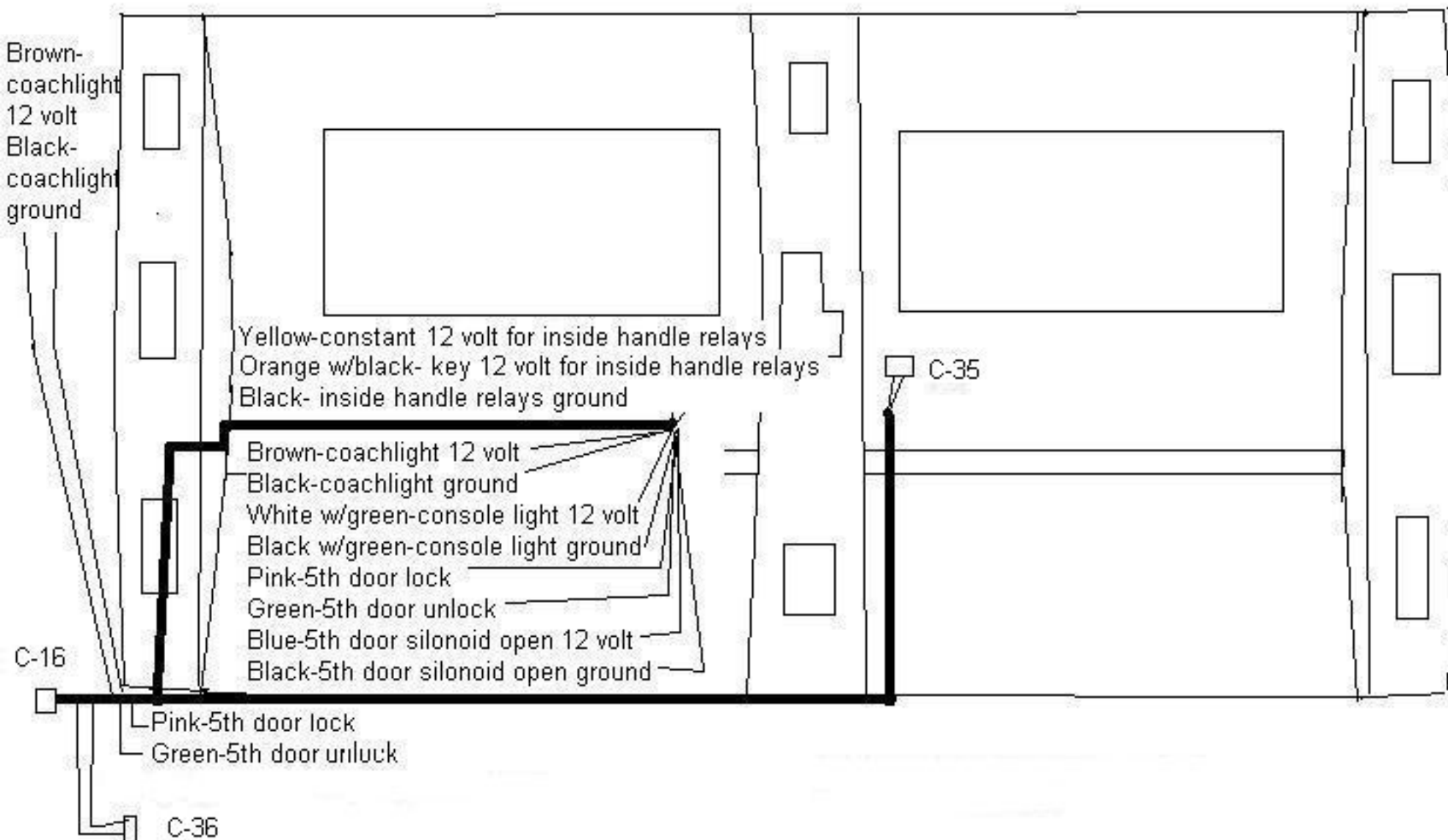

Top View of Limousine

<Front

5th Door Open Harness

5th
Door>

Blue- 5th door open
switched 12 volt
Black- ground

Rear
Door>

Purple- 5th door open
12 volt
Blue- 5th door open
switched 12 volt

13

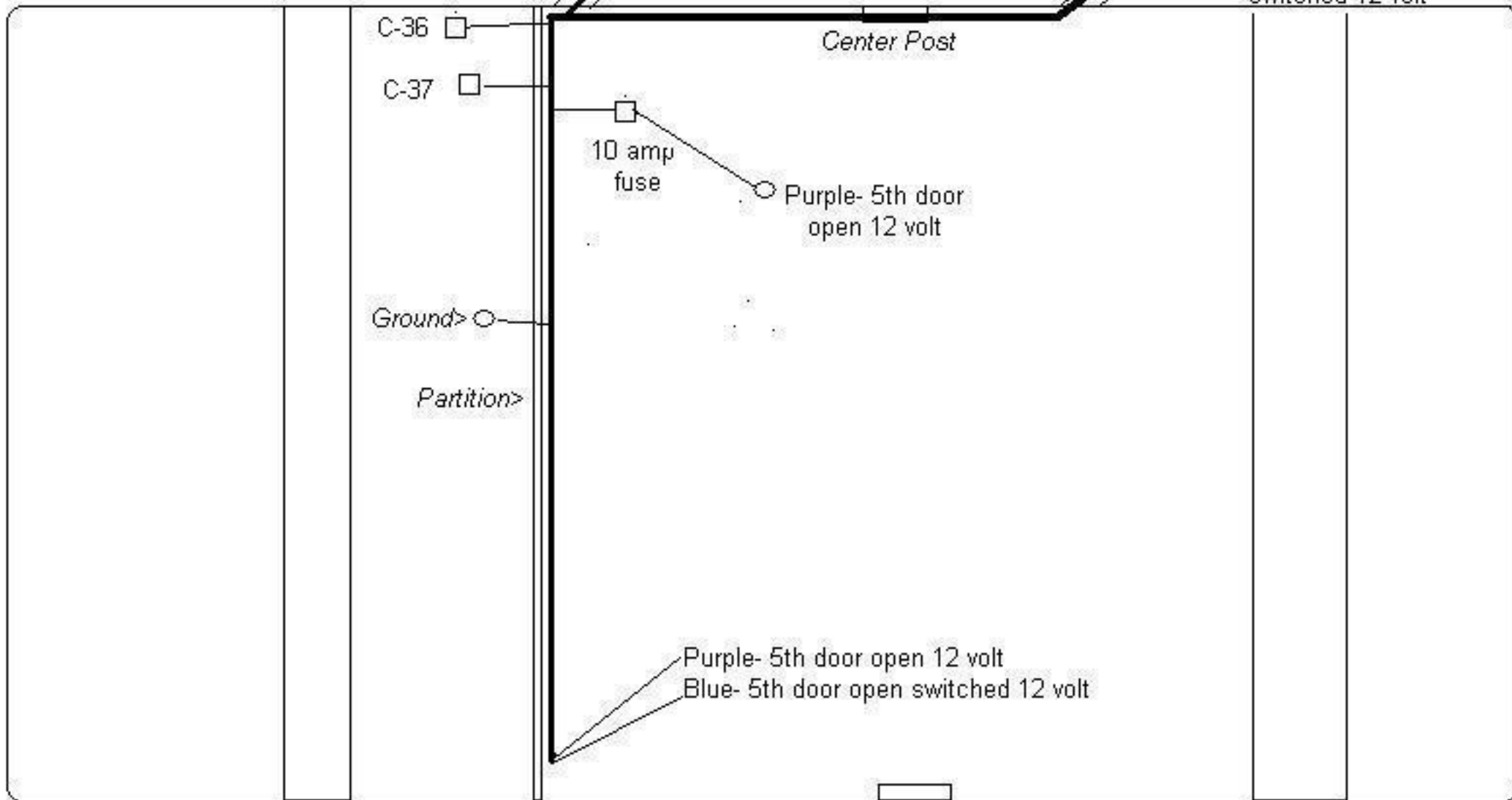

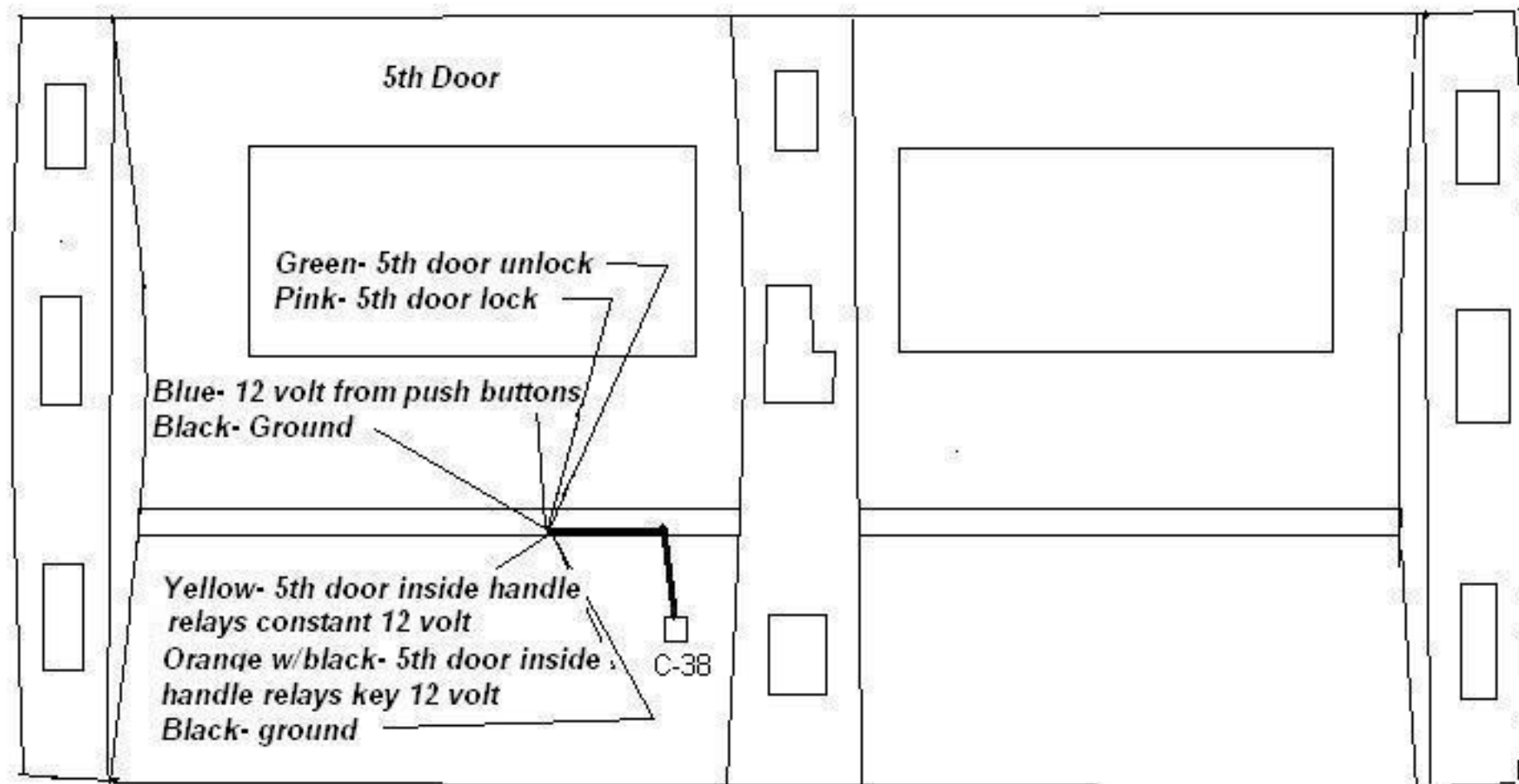

DaBryan Wire Color Codes

Accent- 16ga lt blue	
Ceiling- 16ga white/red	
Ceiling- 16ga black/red controlled ground	
Console- 16ga white/green	
Console- 16ga black/green controlled ground	
Mood- 16ga white/blue	
Mood- 16ga black/blue controlled ground	
Floor- 16ga purple	
Starlight- 16ga green	
Vanity/ no smoke- 16ga yellow	
Coach/Rear protector light- 16ga brown	
Moon roof open - 14ga yellow	
Moon roof close- 14ga green	
Partition up- 14ga yellow	
Partition down- 14ga red	
Glass up- 14ga blue/orange	
Glass down- 14ga red/white	
Subwoofer- 12ga red	
Ice bucket- 14ga dark green	
Video- 14ga blue	
Radio- 14ga red/yellow	
Radio Constant- 14ga yellow/red	
Door open - 14ga blue/orange + activation	
PowerPoint- 14ga red/blue	
Intercom- 18ga red	
Alternator activation- 16ga green GXL	
Con Fan- 12ga blue GXL	
Heat valve- 16ga white GXL	
Aux- 14ga pink	
Main key hot-14ga red/yellow	

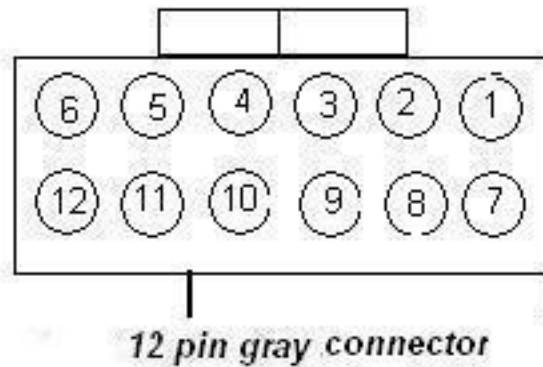
C-1**Location:**

*p/s of partition below relay panel
relay panel and partition main harness*

Pin#

1. Brown- coachlight 12 volt
2. Red- subwoofer 12 volt
3. Red w/blue- power point 12 volt
4. Blue - monitor 12 volt
5. Red w/ yellow- radio key 12 volt
6. Yellow w/red - radio constant 12 volt
7. Purple- floor lights 12 volt
8. Green- ice bucket lights 12 volt
9. White w/red- ceiling lights 12 volt
10. White w/blue- mood lights 12 volt
11. White w/green- console lights 12 volt
12. Yellow- vanity and no smoking lights 12 volt

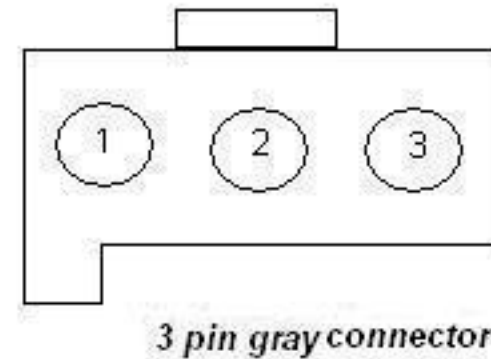
C-2**Location:**

*p/s of partition below relay panel
relay board and partition main harness*

Pin#

- 1 Yellow w/red- radio constant 12 volt
2. Black w/blue- mood light control ground
3. Black w/red- ceiling light control ground

C-3

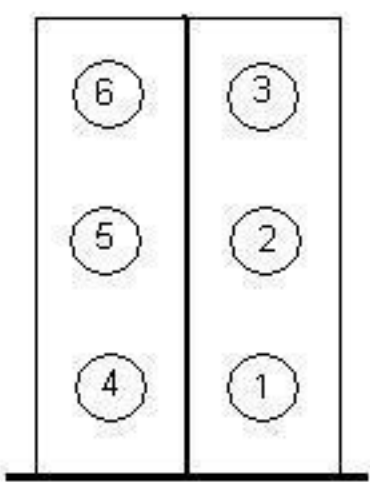

6 pin brown connector

Location:
relay board and underhood harness

Pin#

- 1. Blue- condensor fan 12 volt
- 2. White- heat silonoid 12 volt
- 3. Green- 2nd alternator 12 volt trigger
- 4. Black- ground
- 5. Black- ground
- 6. open

C-4

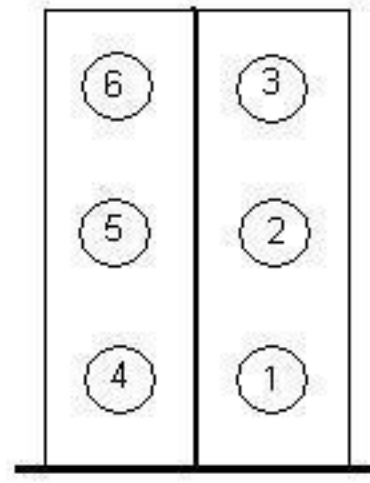

6 pin brown connector

Location:
relay board and factory tie in harness

Pin#

- 1. Red- main key 12 volt for relay board
- 2. Brown- coach light relay 12 volt trigger
- 3. Blue- from door lock switch in rear overhead console
- 4. open
- 5. Blue w/orange- door open relay 12 volt trigger
- 6. Purple- from door unlock switch in rear overhead console

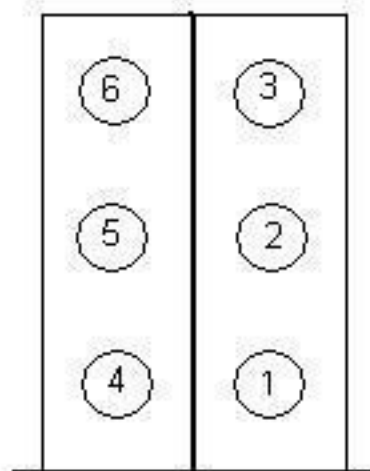
C-5

6 pin brown connector

Location:*relay board and rgb lights harness***Pin#**

- 1.Green- starlight light box 12 volt
- 2.Blue- rgb light box 12 volt
- 3.Pink- aux 1 key 12 volt
- 4.Black- ground
- 5.Black- ground
- 6.Black- ground

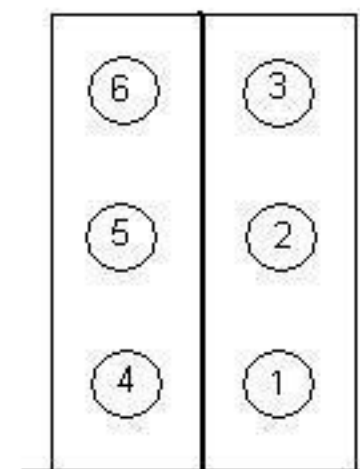
C-6*25 pin Computer cable[rear control]***Location:***relay board and p/s center panel harness*C-7*25 pin Computer cable[front control]***Location:***relay board and front faceplate control cable harness*C-8

6 pin brown connector

Location:*relay board and heat a/c partition harness***Pin#**

- 1.Orange- a/c blower 12 volt
- 2.Orange w/white- combo motor 12 volt
- 3.open
- 4.Black- a/c bypass control ground
- 5.Black- a/c bypass control ground
- 6.Black w/white- heat sinks transistor control

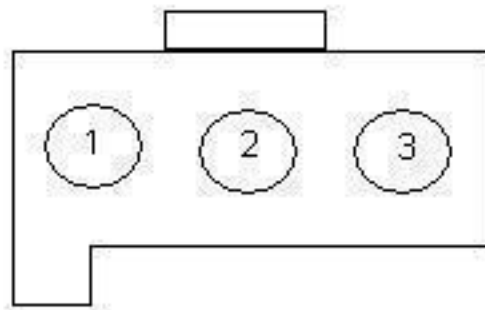
C-9

3 pin gray connector

Location:

Center of partition by privacy panel motor
relay board

Pin#

- 1.Red- partition panel motor
- 2.open
- 3.Yellow- partition panel motor

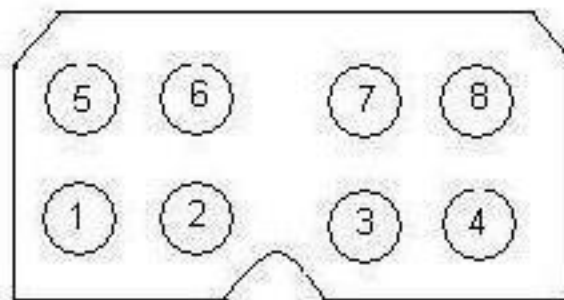
C-10

8 pin blue connector

Location:

plugs into dimmer box on relay board
partition main harness

Pin#

- 1.Black w/red- ceiling light control ground
- 2.Black- ground
- 3.Black- ground
- 4.Black w/green-console lights control ground
- 5.open
- 6.open
- 7.Black-ground
- 8.Black w/blue-mood lights control ground

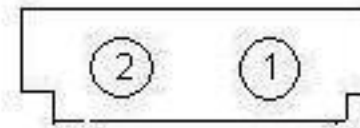
C-11a, C-11b, C-11c

2 pin white connector

Location:

C-11a: center of car by partition at floor
C-11b: p/s center post at floor
C-11c: d/s rear end of j-seat or side seat at floor
partition main harness
p/s center panel
d/s center panel

Pin#

- 1.Black- floor lights ground
- 2.Purple- floor lights 12 volt

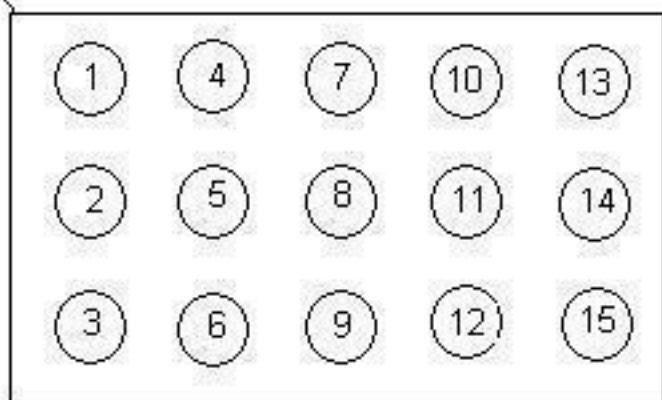

15 pin white connector

Location:

d/s of partition at floor
partition main harness

120 ice bucket light harness [optional]

Pin#

1. White w/green- console lights 12 volt
2. Black w/green-console lights control ground
3. open
4. open
5. open
6. Black- ice bucket lights ground
7. open
8. open
9. open
10. White w/blue- mood lights 12 volt
11. Black w/blue- mood lights control ground
12. open
13. open
14. Green- ice bucket lights 12 volt
15. Black-ground

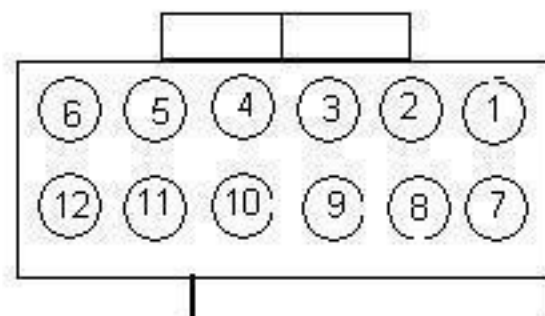

12 pin gray connector

Location:

d/s of partition at floor
partition main harness and d/s center panel harness

Pin#

1. Red- subwoofer 12 volt
2. Blue- monitor 12 volt
3. Purple- floor lights 12 volt
4. Brown- coachlights 12 volt
5. White w/blue-mood lights 12 volt
6. White w/green- console lights 12 volt
7. Black- ground
8. Black- ground
9. Black- ground
10. Black-ground
11. Black w/blue- mood lights control ground
12. Black w/green- console lights control ground

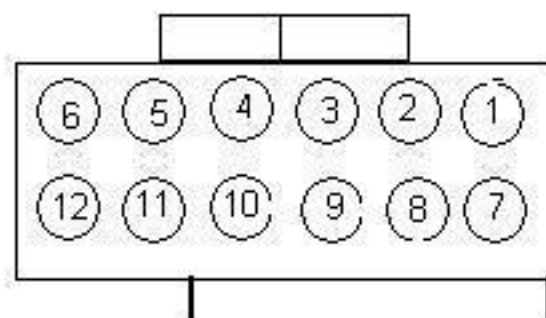
C-14

12 pin gray connector

Location:

*p/s of partition at floor
partition main harness and p/s center panel harness*

Pin#

- 1.Red w/blue- power point 12 volt
- 2.Blue- monitor 12 volt
- 3.Purple- floor lights 12 volt
- 4.Brown- coach lights 12 volt
- 5.Red w/ yellow- radio key 12 volt
- 6.Clear- d/s radio speaker +
- 7.Yellow- vanity and no smoking lights 12 volt
- 8.Yellow w/red- radio constant 12 volt
- 9.White w/green- console lights 12 volt
- 10.White w/blue- mood lights 12 volt
- 11.open
- 12.Clear- d/s radio speaker -

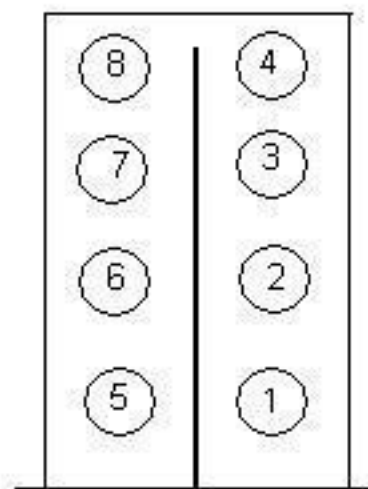
C-15

8 pin gray connector

Location:

*p/s of partition at floor
main partition harness and p/s center panel harness*

Pin#

- 1.Black- ground
- 2.Black- ground
- 3.Black- ground
- 4.Black- Ground
- 5.Black- ground
- 6.Black w/green- console lights control ground
- 7.Black- ground
- 8.Black w/blue- mood lights control ground

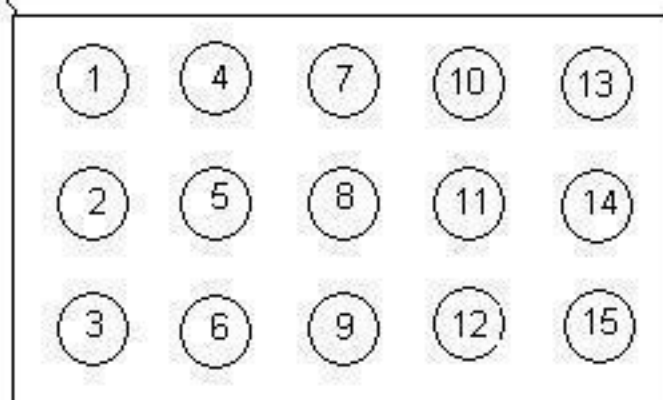
C-16

15 pin white connector

Location:*p/s of partition at floor**partition main harness , 5th door car harness and 120 console harness[optional]***Pin#**

- 1.White w/green- console lights 12 volt
- 2.Black w/green- console lights control ground
- 3.open
- 4.open
- 5.open
- 6.Black- ice bucket lights ground
- 7.open
- 8.open
- 9.open
- 10.White w/blue- mood lights 12 volt
- 11.Black w/blue- mood lights control ground
12. open
13. open
- 14.Green- ice bucket lights 12 volt
- 15.Black- ground

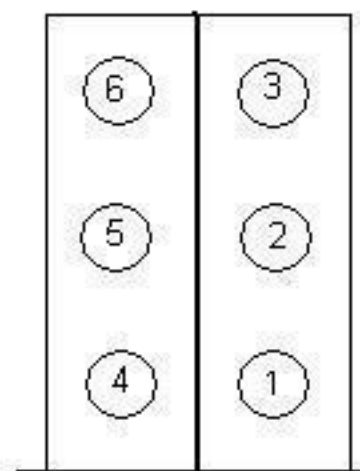
C-17

6 pin brown connector

Location:*p/s of partition behind lower filler
partition main harness and roof harness***Pin#**

- 1.White w/green- console lights 12 volt
- 2.White w/red- ceiling lights 12 volt
- 3.Yellow- vanity and no smoking lights 12 volt
- 4.Black w/green- console lights control ground
- 5.Black w/red- ceiling lights control ground
- 6.Black- ground

C-18

15 pin Computer cable

Location:
plugs into dimmer box

C-20a, C-20b, C-20c, C-20d, C-20e, C-20f



2 pin white connector

Location:

- C-20a: and C-20b: p/s center post at ceiling
- C-20c: d/s rear end of j-seat or side seat at floor
- C-20d:and C-20e:d/s center post at ceiling
- C-20f: front end of mirror ceiling

- p/s center panel harness
- d/s center panel harness
- roof harness

Pin#

- 1.Black w/green- console lights control ground
- 2.White w/green- console lights 12 volt

C-19a, C-19b, C-19c



2 pin white connector

Location:

- C-19a: p/s center post by center window
- C-19b: p/s rear post {C post} by center window
- C-19c: d/s rear post {C post} by center window
- p/s center panel harness
- d/s center panel harness

Pin#

- 1.Black- ground
- 2.Blue- monitor 12 volt

C-21a, C-21b, C-21c, C-21d

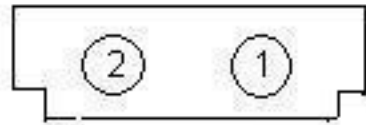

2 pin white connector

Location:

- C-21a: and C-21b: p/s center post at ceiling*
- C-21c: and C-21d: d/s center post at ceiling*
- p/s center panel harness*
- d/s center panel harness*

Pin#

- 1.Black w/blue: mood lights control ground*
- 2.White w/blue: mood lights 12 volt*

C-22

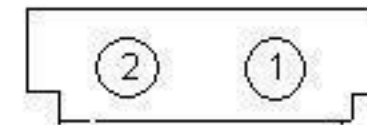

2 pin white connector

Location:

- rear overhead console*
- rear of limousine harness*

Pin#

- 1.Black- ground*
- 2.Brown- coachlight 12 volt*

C-23a, C-23b, C-23c

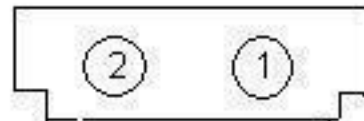

2 pin white connector

Location:

C23a: and C-23b: rear of limousine harness

C23c: roof harness

Pin#

1.Black- ground

2.Yellow- vanity and no smoking lights 12 volt

C-24

25 pin Computer cable

Location:

rear of limousine harness

C-25

25

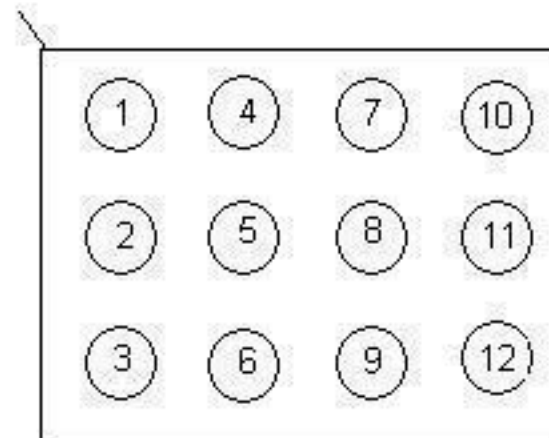

12 pin white connector

Location:

rear of limousine harness

Pin#

1.Clear- left front speaker -

2.Clear- left front speaker+

3.Yellow w/red-radio constant 12 volt

4.Clear- right front speaker-

5.Clear- right front speaker+

6.Orange- power antenna 12 volt trigger

7.Black- right rear speaker -

8.Red- right rear speaker +

9.Red w/yellow- radio key 12 volt

10.Black- left rear speaker -

11.Red- left rear speaker +

12.Black- ground

C-26

15 pin Computer cable

Location:
rear overhead console harness

C-28a, C-28b



4 pin white plug

Location:
C-28a : p/s above partition
C-28b: d/s above partition
roof harness

Pin#

- 1.open
- 2.Green w/orange- factory domelight 12 volt
- 3.Black w/blue- factory domelight door open 12 volt
- 4.Black- ground

C-27a, C-27b, C-27c, C-27d, C-27e, C-27f, C-27g, C-27h

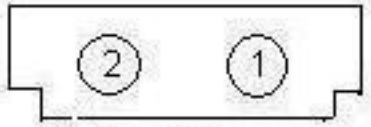

2 pin white connector

Location:

- C-27a: in ceiling by p/s rear door
- C-27b: in ceiling rear of p/s center post
- C-27c: in ceiling front of rear compartment on p/s
- C-27d and C-27e in ceiling above center of partition
- C-27f: in ceiling front of rear compartment on d/s
- C-27g: in ceiling rear of d/s center post
- C-27h: in ceiling by d/s rear door

roof harness

Pin#

- 1.Black w/red- ceiling lights control ground
- 2.White w/ red- ceiling lights 12 volt

C-29

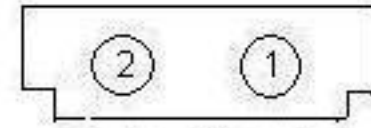

2 pin white plug

Location:
d/s above partition
roof harness

Pin#

- 1.Green- factory 3rd brake light 12 volt
- 2. open

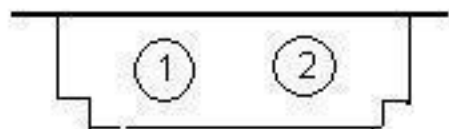
C-30

2 pin gray connector

Location:

d/s of partition at floor
heat and a/c partition harness

Pin#

- 1.Black- a/c bypass and a/c motor control ground
- 2.Black w/white- heat sinks transistor control

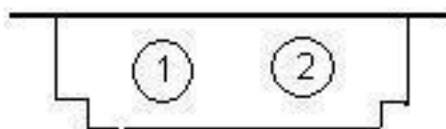
C-31

2 pin gray connector

Location:

d/s of partition at floor
heat and a/c partition harness

Pin#

- 1.Black- combo bypass and combo motor control ground
2. Black w/white- heat sinks transistor control

C-32

25 pin Computer cable

Location:

C-41- behind front control panel in dash
front faceplate control cable harness

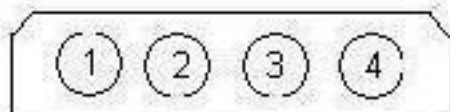
C-33a, C-33b, C-33c, C-33d, C-33e, C-33f, C-33gC-33h, C-33i

4 pin white plug

Location:

C-33a and C-33b p/s center post at ceiling

C-33c front end of ceiling mirror

C-33d and C-33e d/s center post at ceiling

C-33f rear end of j-seat or side seat at floor

C-33g and C-33h d/s of partition at floor

C-33i p/s of partition at floor

rgb lights harness

Pin#

1. Pink w/yellow- rgb red light

2. Green- rgb green light

3. Blue- rgb blue light

4. Black w/orange-rgb 12 volt

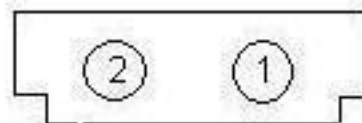
C-34

2 pin white connector

Location:

d/s of partition at floor

rgb light harness

Pin#

1. Black- ground

2. Red- rgb module 12 volt

C-35

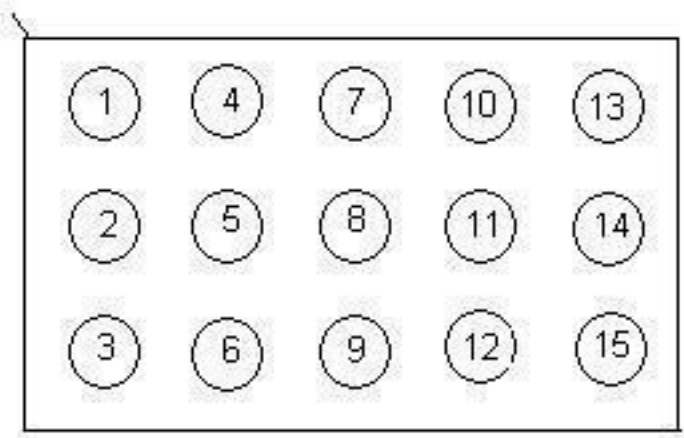

15 pin white connector

Location:

*p/s center post by bottom of window
5th door car harness*

Pin#

- 1.White w/green- console lights 12 volt*
- 2.Black w/green- console lights control ground*
- 3.open*
- 4.open*
- 5.open*
- 6.Black- ice bucket lights ground*
- 7.open*
- 8.open*
- 9.open*
- 10.open*
- 11.open*
- 12 open*
- 13 open*
- 14.Green- ice bucket light 12 volt*
- 15.Black- ground*

C-36

4 pin white connector

Location:

*p/s of partition at floor
5th door open and 5th door car harness*

Pin#

1. Yellow- 5th door inside handle relays constant 12 volt
2. Orange w/black- 5th door inside handle relays key 12 volt
3. Blue- 12 volts from 5th door open push buttons
4. Black- ground

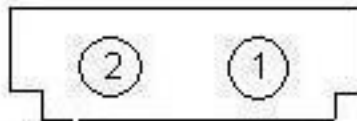
C-37

2 pin white connector

Location:

*p/s of partition at floor
5th door open harness
relay board*

Pin#

1. Orange w/black- 5th door inside handle relays key 12 volt
2. open

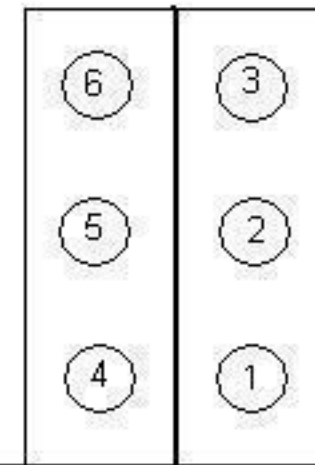
C-38

6 pin brown connector

Location:

*Inside 5th door
5th door relay harness*

Pin#

1. Green- 5th door unlock
2. Blue- 12 volts from inside handle
3. Black- ground
4. Pink- 5th door lock
5. Blue- 12 volts from push buttons
6. Orange w/black- key 12 volt to 5th door relays